

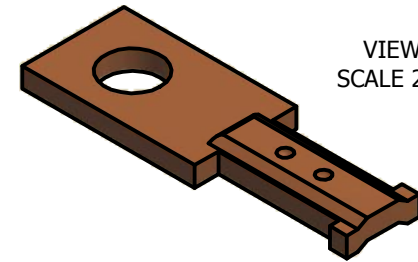

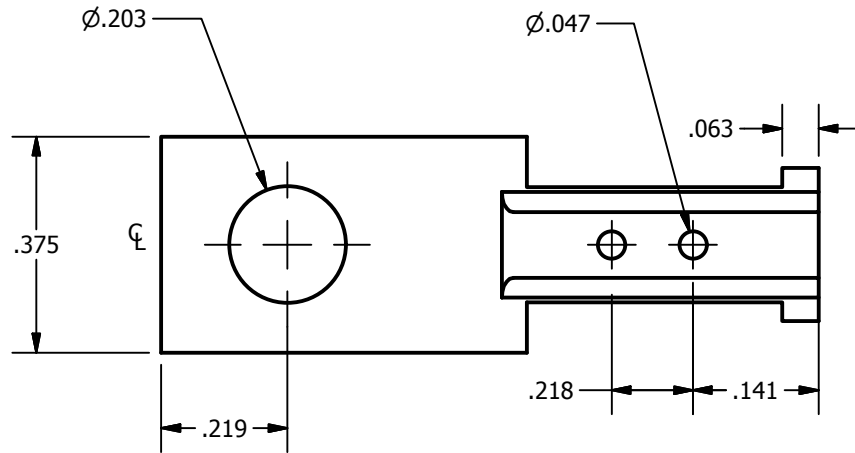

SCREW: NONE	MATERIAL: COPPER	REV: C	 800-776-9775 www.ilsco.com		
CAT. NO.: SLS-35	PLATING: SEE CHART	DRAWN BY: JG			SCALE: 3=1
INFORMATION SHEET: FORM 12	MARKING: SEE CHART	DATE: 6/4/2007			SIZE: A
		DWG. NO.		F0012	
		SHEET: 1 OF 1			

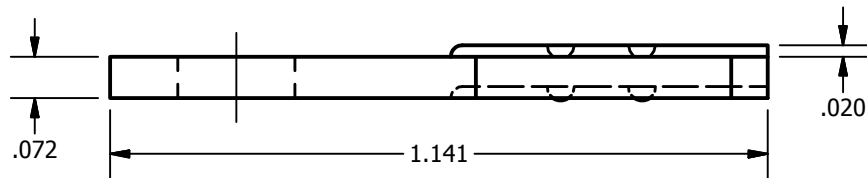

VIEW9
SCALE 2 : 1



DEV	MARKING	PLATING
C00B	SLS 35 	BRIGHT DIP
C04T	F12-4 	EL-TIN
C10B	STC 0614 	BRIGHT DIP